

40

Neurochirurgie, Laminektomie
Neurosurgery, Laminectomy
Neurochirurgie, Laminectomie
Neurocirugía, Laminectomía
Neurochirurgia, Laminectomia

Hirnaht
 Brain Suture
 Suture cérébrale
 Sutura cerebral
 Sutura cerebrale

dimed[®]

SURGICAL INSTRUMENTS

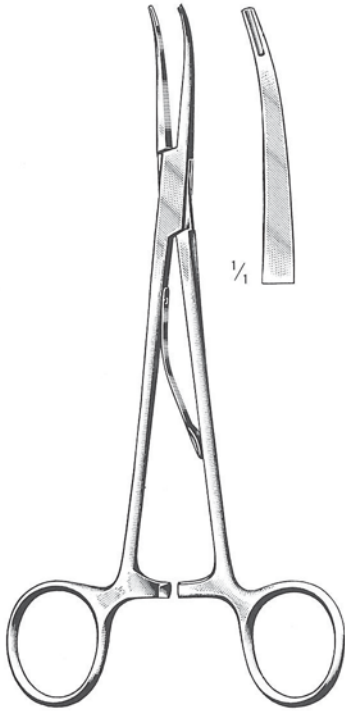

| | |
|----|-----------|
| cm | McKENZIE |
| 15 | 40.011.15 |
| 19 | 40.011.19 |

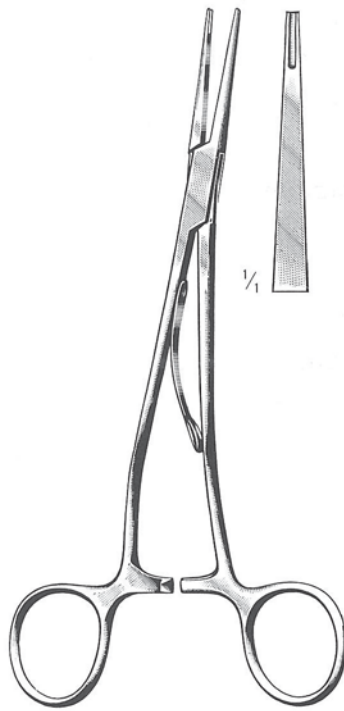

| | |
|----|-----------|
| cm | McKENZIE |
| 15 | 40.013.15 |
| 19 | 40.013.19 |

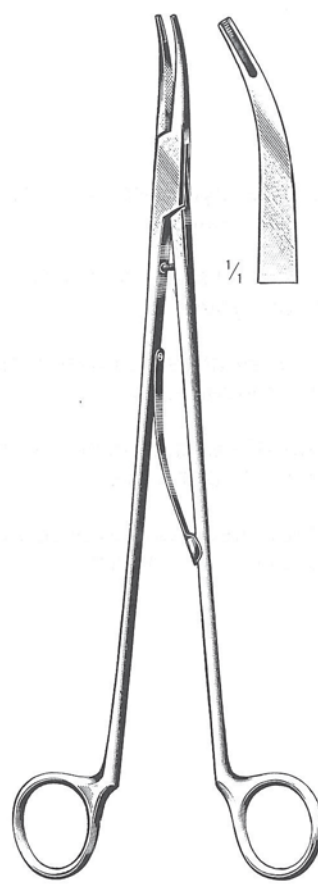

| | |
|----|-----------|
| cm | SMITHWICK |
| 23 | 40.015.23 |
| 26 | 40.015.26 |

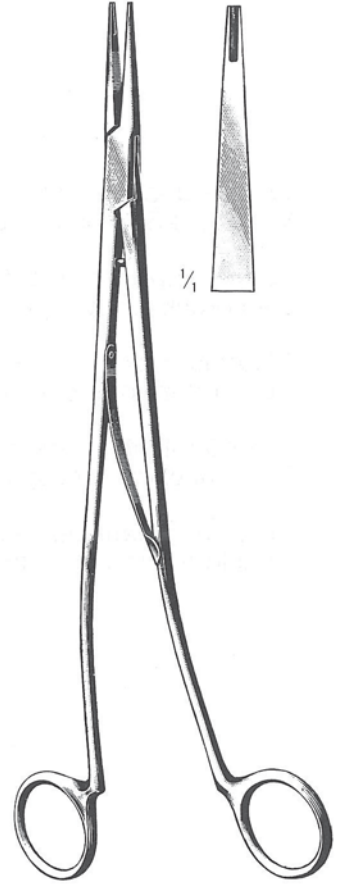

| | |
|----|-----------|
| cm | SWEET |
| 23 | 40.017.23 |
| 26 | 40.017.26 |



OLIVECRONA-TOENNIS
 40.019.14

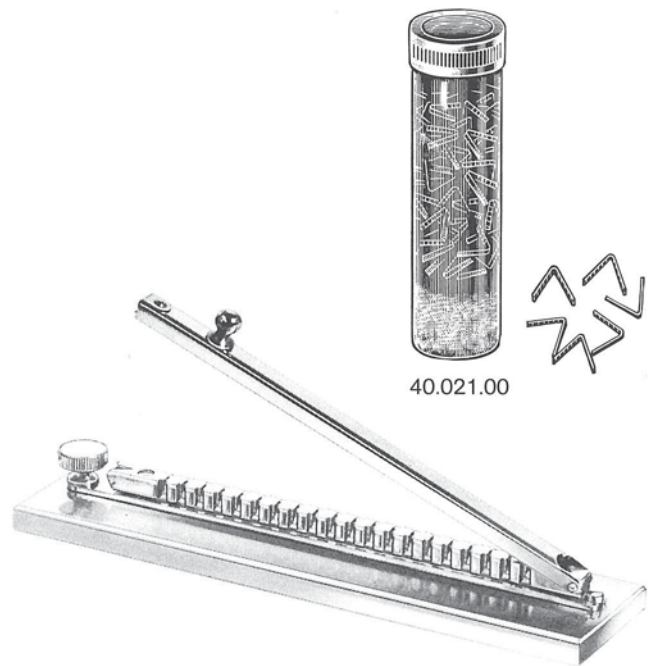

40.020.00
 148x40x6 mm

Schädelhalter
Cervical Traction Tongs
Pinces de traction crânienne
Pinzas de tracción craneal
Pinze per trazione craniale

dimeda[®]

SURGICAL INSTRUMENTS

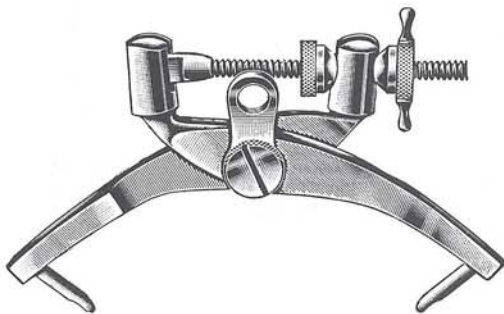

CRUTCHFIELD
40.025.01



CRUTCHFIELD
40.025.02



40.026.35
3,5 mm Ø



40.026.50
5 mm Ø

Kopfhautklammer, -anlegezange
Scalp Hemostasis Clip, Applying Forceps
Pince hémostatique pour le cuir chevelu, pince à poser
Pinza hemostática para cuero cabelludo, pinza para poner
Pinza emostatica per il cuoio capelluto, pinza per applicare e togliere



RANEY
40.027.00

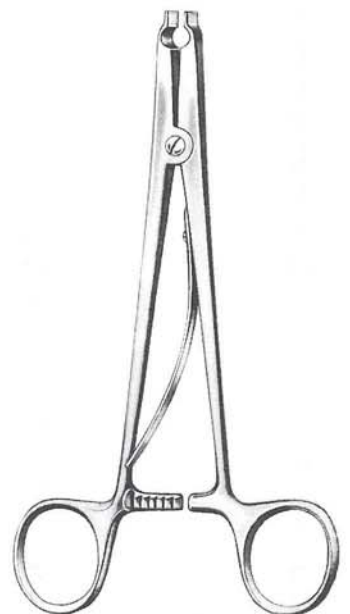

RANEY
40.028.00

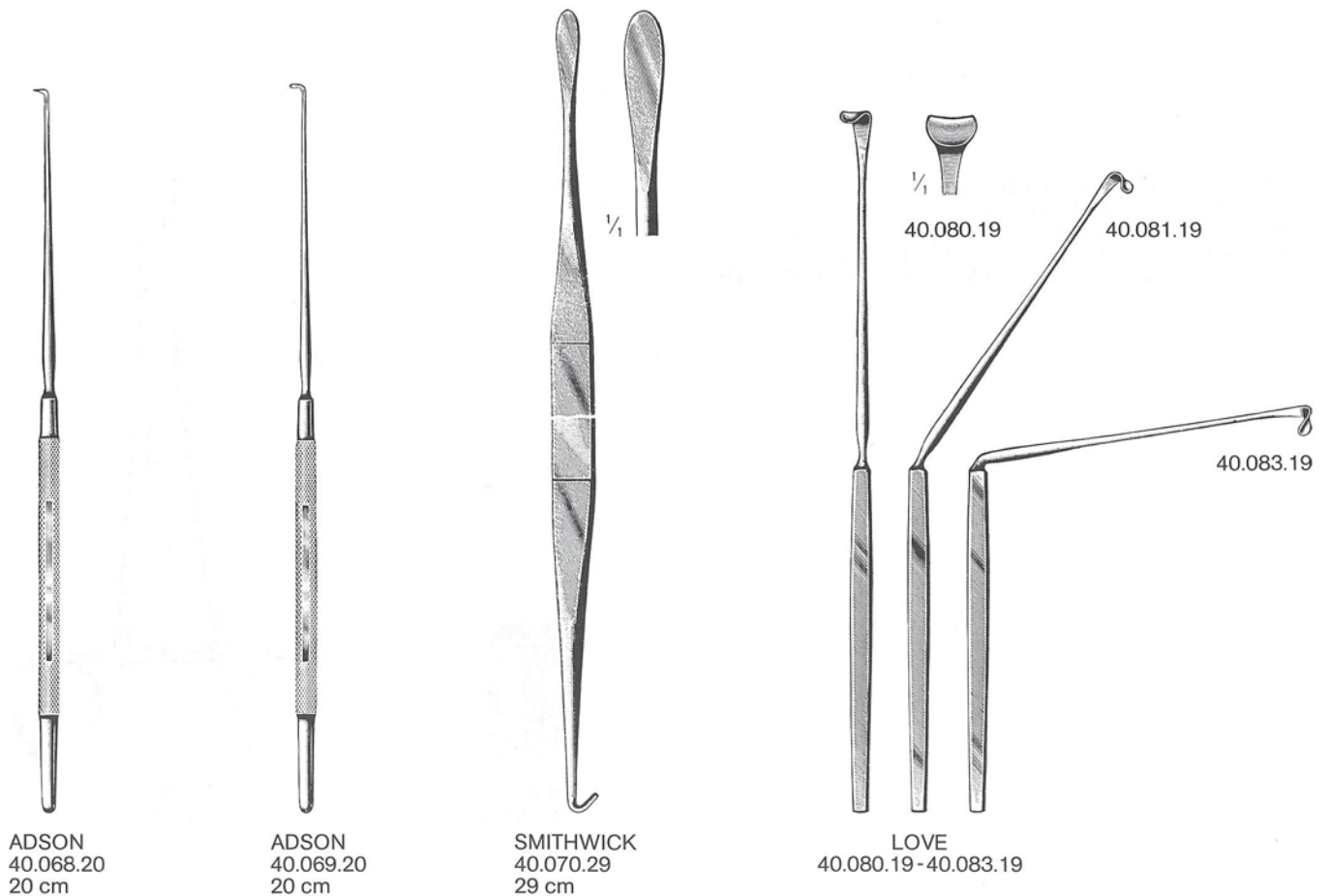
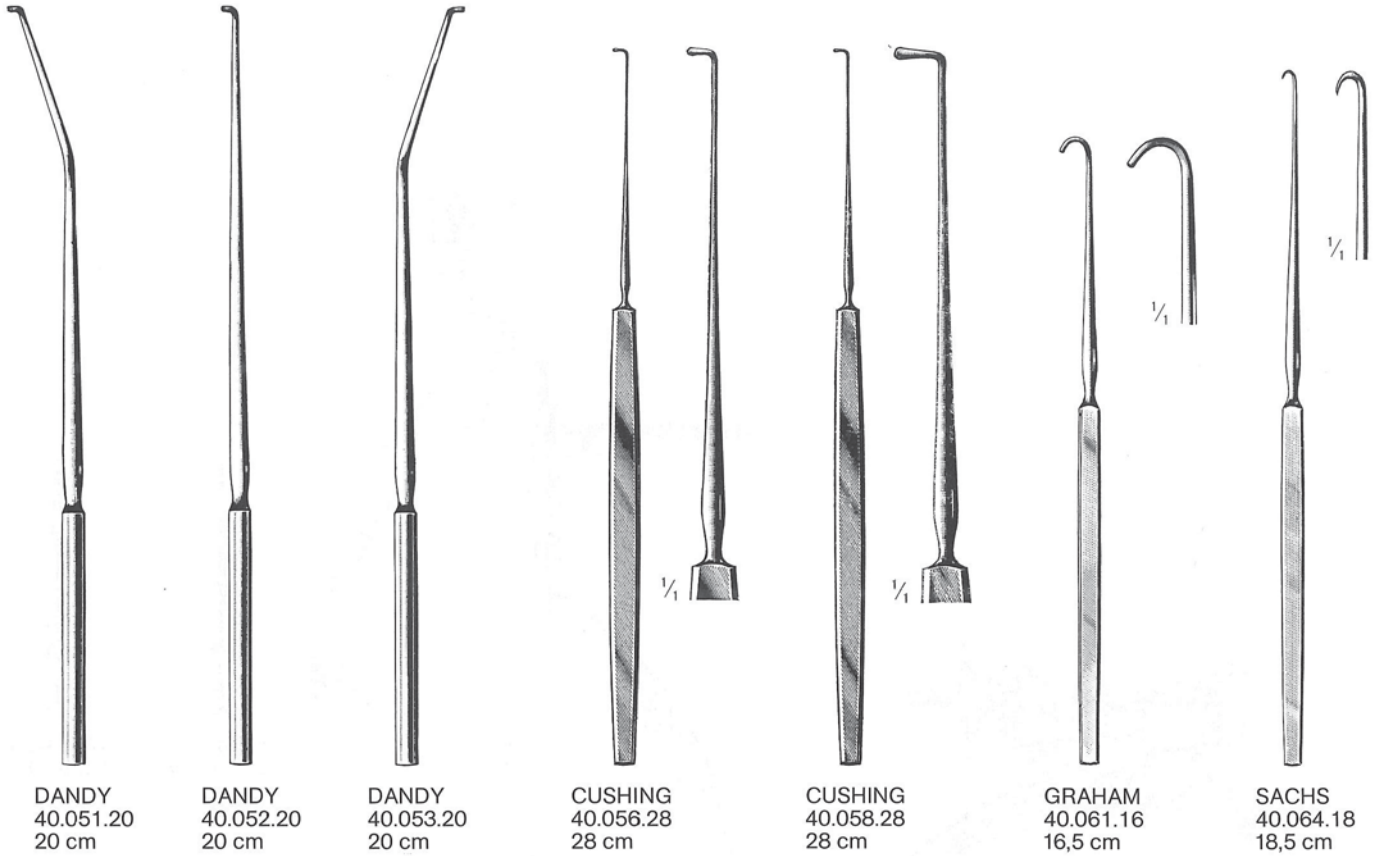



De MARTEL
 40.090.33
 33 cm



De VILBISS
 40.096.21
 21 cm

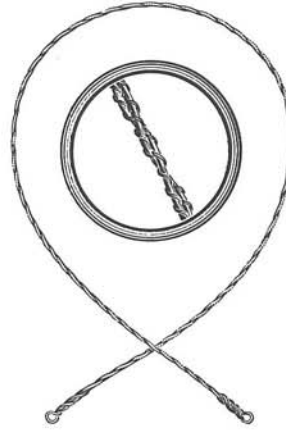

| cm | OLIVECRONA |
|----|------------|
| 30 | 40.092.30 |
| 40 | 40.092.40 |
| 50 | 40.092.50 |
| 60 | 40.092.60 |
| 70 | 40.092.70 |

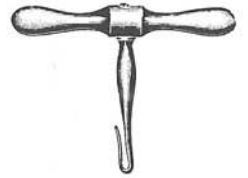

GIGLI
 40.094.00
 1 Paar
 1 pair
 1 paire
 1 par
 1 paio

Dura-Dissektoren · Dura Dissectors · Dissecteurs à duremère
 Descoladores para la duramadre · Scollatori per la duramadre



TOENNIS
 40.141.25
 25 cm



SACHS
 40.143.21

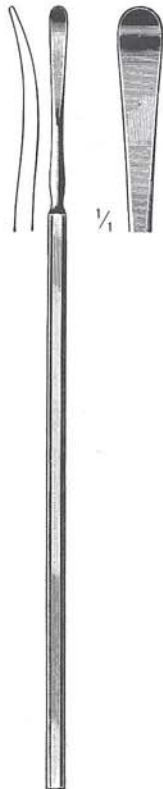

SACHS
 40.145.21

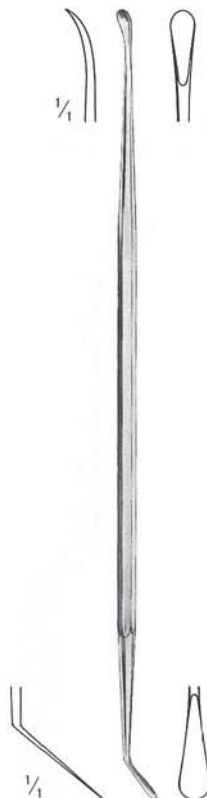

MILLIGAN
 40.147.21

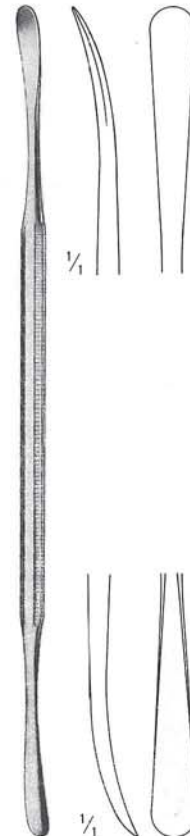

40.149.22



DAVIS
 40.151.24

Dura-Dissektoren, -Messer
 Dura Dissectors, Knife
 Dissecteurs, bistouri à duremère
 Descoladores, bisturi para duramadre
 Scollatori, bisturi per duramadre



PENFIELD
 40.161.01
 17,5 cm

PENFIELD
 40.161.02
 19,5 cm

PENFIELD
 40.161.03
 19,5 cm

PENFIELD
 40.161.04
 20,5 cm

PENFIELD
 40.161.05
 18,5 cm

HALLE
 40.170.20

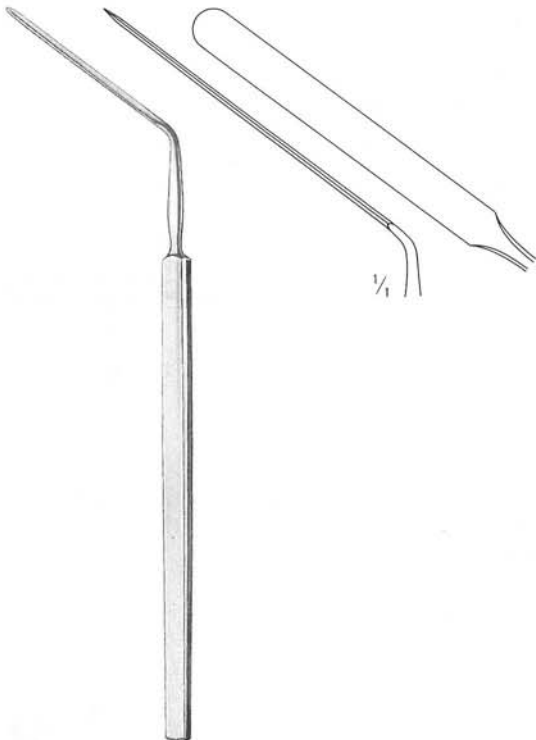

HORSLEY
 40.155.20

Hypophysenpinzetten · Hypophyseal Forceps · Pincas à hypophyse · Pinzas para hipófisis · Pinze per ipofisi

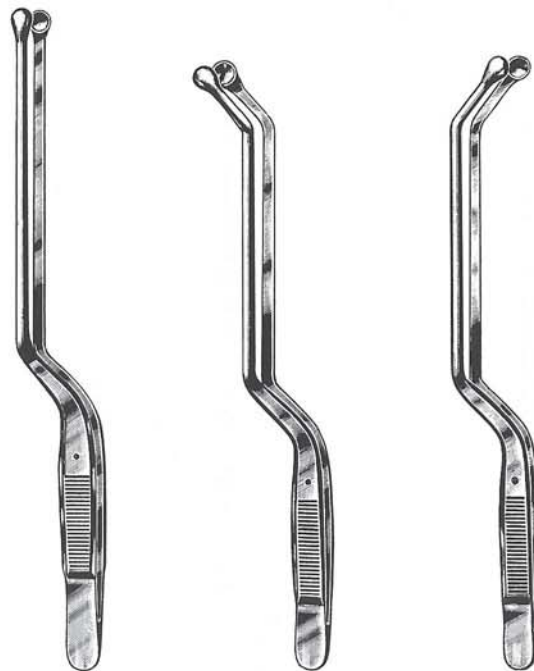

ADSON
 40.210.23

ADSON
 40.211.23

ADSON
 40.213.23

Hirnspatel, Saugrohre
 Brain Spatulas, Aspiration Tubes
 Spatules cérébr., tubes d'aspir.
 Espátulas cerebr., tubos de aspir.
 Spatole cerebr., tubi per aspiraz.

dimed®

SURGICAL INSTRUMENTS



mm CUSHING
 7/ 9 40.250.07
 11/13 40.250.11
 15/18 40.250.15
 18/22 40.250.18
 180 mm



mm OLIVECRONA
 7/ 9 40.253.07
 11/13 40.253.11
 15/18 40.253.15
 18/22 40.253.18
 180 mm



mm HEIFETZ
 8 40.260.08
 11 40.260.11
 14 40.260.14
 17 40.260.17



ADSON
 40.290.21
 21 cm/4 mm

| Charr. F.G. | 30° | 75° |
|----------------|-----------|-----------|
| 6 | 40.295.06 | 40.297.06 |
| 7 | 40.295.07 | 40.297.07 |
| 8 | 40.295.08 | 40.297.08 |
| 9 | 40.295.09 | 40.297.09 |
| 10 | 40.295.10 | 40.297.10 |
| 11 | 40.295.11 | 40.297.11 |
| 12 | 40.295.12 | 40.297.12 |
| 15 | 40.295.15 | 40.297.15 |



FRAZIER
 40.295.06-40.297.12
 19 cm

Wirbelkörperspreizer · Lamina Spreaders ·
 Ecarteurs pour corps vertébraux ·
 Separadores para cuerpos vertebrales ·
 Divaricatori per corpi vertebrali



FRAZIER
 40.298.12
 12 cm/3 mm



CLOWARD
 40.401.16



INGE
 40.405.17-40.405.27

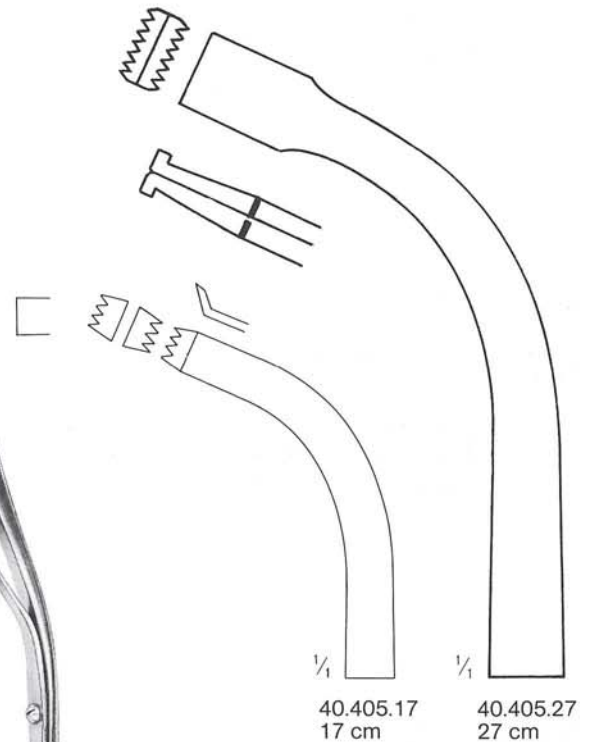

40.405.17
 17 cm

40.405.27
 27 cm

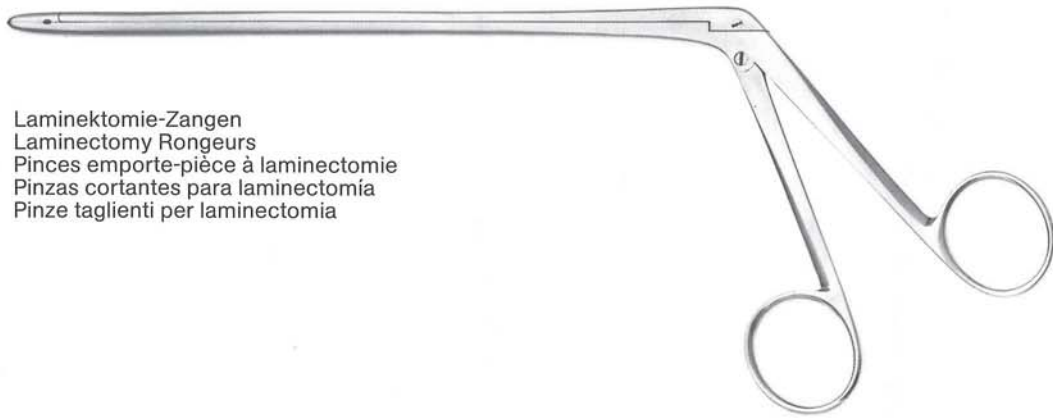

Laminektomie-Zangen
 Laminectomy Rongeurs
 Pincas emporte-pièce à laminectomie
 Pinzas cortantes para laminectomia
 Pinze taglienti per laminectomia

CUSHING
 2 mm



| 2x 10 mm | L |
|-----------|---------|
| 40.420.01 | 12,5 cm |
| 40.422.01 | 18,0 cm |



| 2x 10 mm / 45° | L |
|----------------|---------|
| 40.420.02 | 12,5 cm |
| 40.422.02 | 18,0 cm |

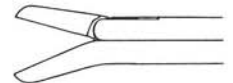

| 2x 10 mm / 45° | L |
|----------------|---------|
| 40.420.03 | 12,5 cm |
| 40.422.03 | 18,0 cm |

LOVE-GRUENWALD
 3 mm



| 3x 10 mm | L |
|-----------|---------|
| 40.430.01 | 12,5 cm |
| 40.432.01 | 18,0 cm |



| 3x 10 mm / 45° | L |
|----------------|---------|
| 40.430.02 | 12,5 cm |
| 40.432.02 | 18,0 cm |

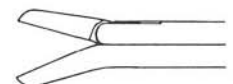

| 3x 10 mm / 45° | L |
|----------------|---------|
| 40.430.03 | 12,5 cm |
| 40.432.03 | 18,0 cm |

SPURLING
 4 mm



| 4x 10mm | L |
|-----------|---------|
| 40.440.01 | 12,5 cm |
| 40.442.01 | 18,0 cm |



| 4x 10mm / 45° | L |
|---------------|---------|
| 40.440.02 | 12,5 cm |
| 40.442.02 | 18,0 cm |

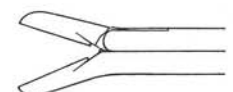

| 4x 10mm / 45° | L |
|---------------|---------|
| 40.440.03 | 12,5 cm |
| 40.442.03 | 18,0 cm |

Laminektomie
 Laminectomy
 Laminectomie
 Laminectomía
 Laminectomia

dimed[®]

SURGICAL INSTRUMENTS

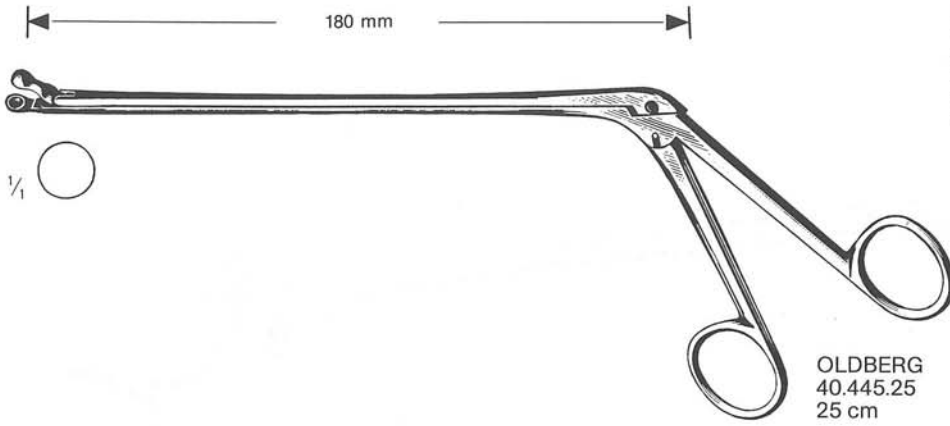

Laminektomie-Zangen
 Laminectomy Rongeurs
 Pinces emporte-pièce à laminectomie
 Pinzas cortantes para laminectomía
 Pinze taglianti per laminectomia

OLDBERG
 40.445.25
 25 cm

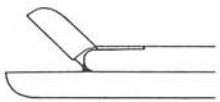

| L | |
|-------|-----------|
| 16 cm | 40.450.01 |
| 18 cm | 40.452.01 |



| L | |
|-------|-----------|
| 16 cm | 40.450.02 |
| 18 cm | 40.452.02 |

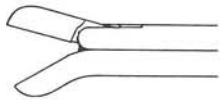

| L | |
|-------|-----------|
| 16 cm | 40.450.03 |
| 18 cm | 40.452.03 |

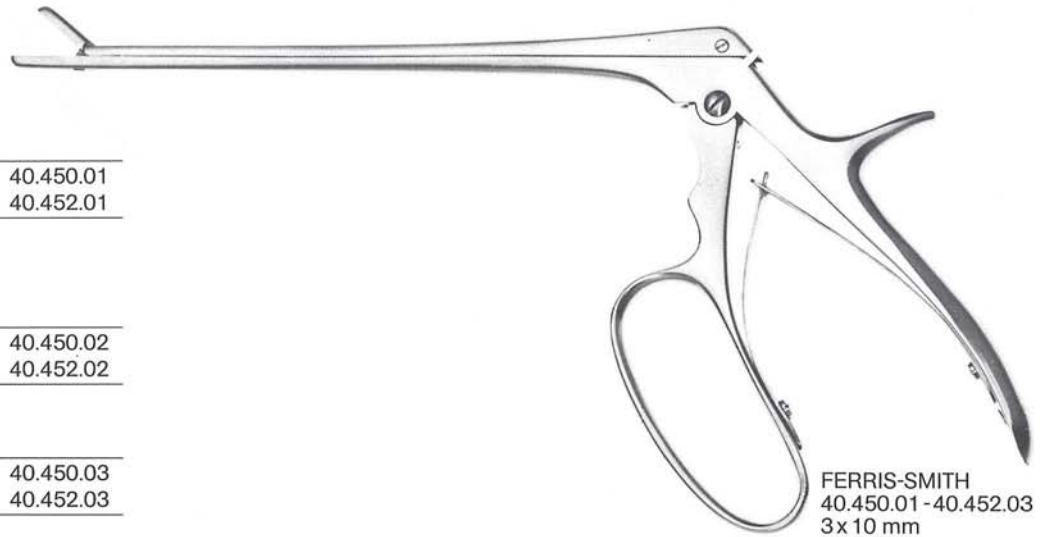

FERRIS-SMITH
 40.450.01 - 40.452.03
 3 x 10 mm



WAGNER
 40.458.20
 20 cm / 4 mm

Bandscheiben-Stanzen
 Intervertebral Disc Rongeurs
 Pinces emporte-pièce pour lames intervertébrales
 Pinzas sacabocado para discos intervertebrales
 Pinze taglienti per dischi intervertebrali

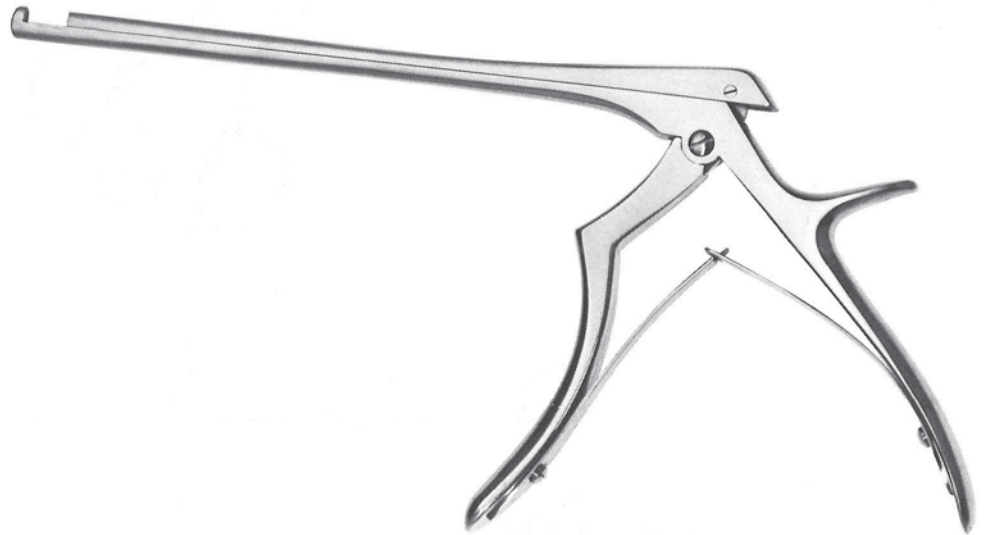

FERRIS-SMITH-KERRISON
 40.510.01 - 40.512.05
 18 cm

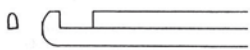

40.510.01
 1 mm

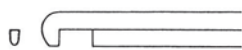

40.511.01
 1 mm

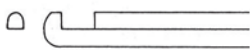

40.510.02
 2 mm

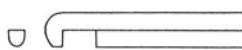

40.511.02
 2 mm

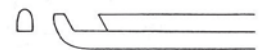

40.512.02
 2 mm

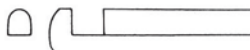

40.510.03
 3 mm

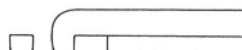

40.511.03
 3 mm



40.512.03
 3 mm



40.510.04
 4 mm

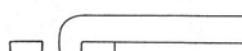

40.511.04
 4 mm



40.510.05
 5 mm

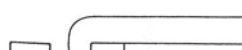

40.511.05
 5 mm



40.512.05
 5 mm

Bandscheiben-Stanzen
 Intervertebral Disc Rongeurs
 Pincas emporte-pièce pour lames intervertébrales
 Pinzas sacabocado para discos intervertebrales
 Pinze taglianti per dischi intervertebrali



COLCLOUGH
 40.520.03-40.525.05

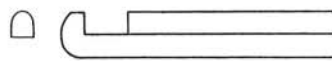

| L | 3 mm |
|-------|-----------|
| 15 cm | 40.520.03 |
| 20 cm | 40.522.03 |

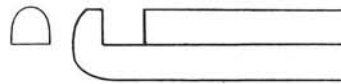

| L | 5 mm |
|-------|-----------|
| 15 cm | 40.520.05 |
| 20 cm | 40.522.05 |

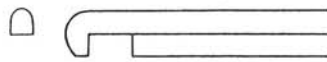

| L | 3 mm |
|-------|-----------|
| 15 cm | 40.524.03 |
| 20 cm | 40.526.03 |

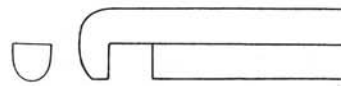

| L | 5 mm |
|-------|-----------|
| 15 cm | 40.524.05 |
| 20 cm | 40.526.05 |

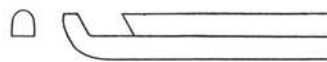

| L | 3 mm |
|-------|-----------|
| 15 cm | 40.527.03 |
| 20 cm | 40.529.03 |

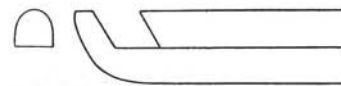

| L | 5 mm |
|-------|-----------|
| 15 cm | 40.527.05 |
| 20 cm | 40.529.05 |

**Verlangen Sie unseren Spezialkatalog für die Aneurysmen Clips
Please ask for our special catalogue for aneurysm clips
Demandez notre catalogue spécial pour aneurysm clips
Pidan nuestro catálogo especial para aneurysm clips
Chiedete il nostro catalogo speciale per aneurysm clips**

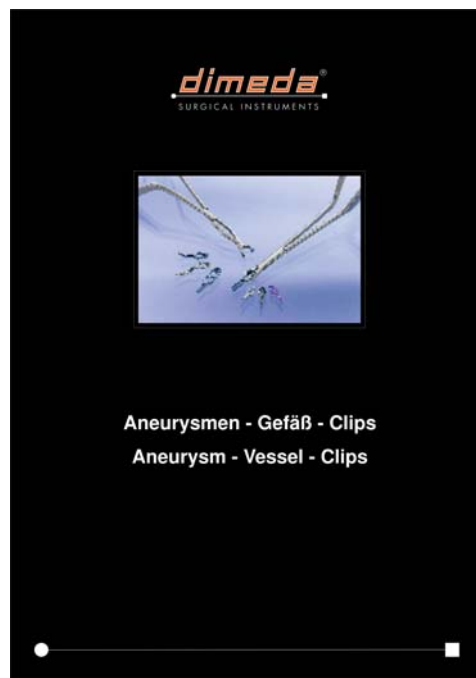

Verlangen Sie unseren Spezialkatalog für die Aneurysmen Clips
Please ask for our special catalogue for aneurysm clips
Demandez notre catalogue spécial pour aneurysm clips
Pidan nuestro catálogo especial para aneurysm clips
Chiedete il nostro catalogo speciale per aneurysm clips

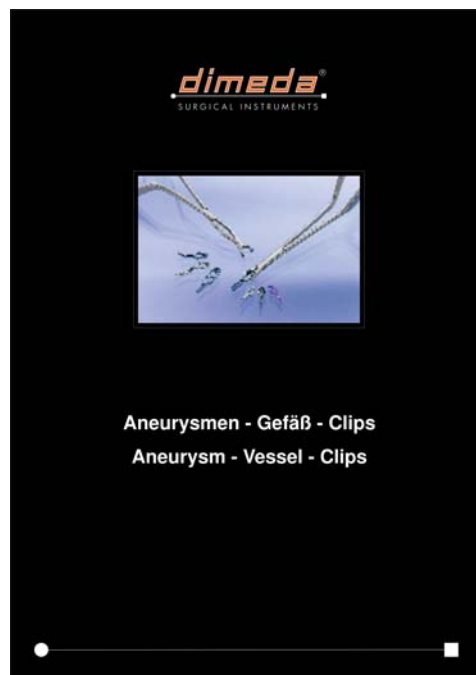

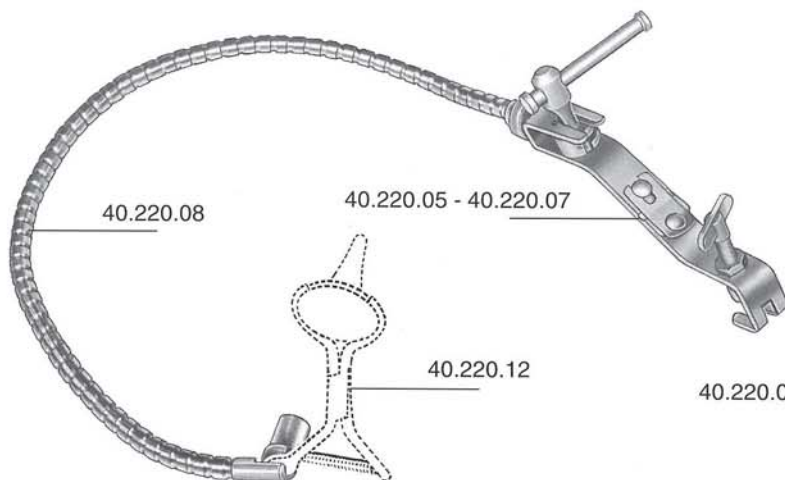

- 40.220.08 Spannarm allein
 Flexible arm only
 Bras flexible seul
 Brazo flexible suelto
 Braccio flessibile solo
- 40.220.12 Ohrtrichterhalter allein
 Ear specula holder only
 Support pour spéculum auriculaire
 Soporte para espéculo de oídos
 Sostegno per specolo auricolare
- 40.220.05 Fixiervorrichtungen für Schädel oder Starrarm
 40.220.06 Fixation bases for skull or rigid holding arm
 40.220.07 Bases pour fixation au crâne ou au bras rigide
 Fijadores para fijación al craneo o al brazo rígido
 Fissatori per fissaggio al cranio o al braccio rigido

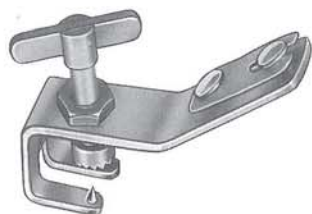

40.220.05

- 40.220.05 Fixiervorrichtung am Schädel für 1 Arm
 Fixation base for 1 arm at skull
 Base de fixation pour 1 bras au crâne
 Fijador para 1 brazo al craneo
 Fissatore per 1 braccio al cranio

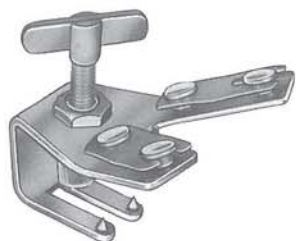

40.220.06

- 40.220.06 Fixiervorrichtung am Schädel für 2 Arme
 Fixation base for 2 arms at skull
 Base de fixation pour 2 bras au crâne
 Fijador para 2 brazos al craneo
 Fissatore per 2 bracci al cranio



40.220.07

- 40.220.07 Fixiervorrichtung am Starrarm für 1 Arm
 Fixation base for 1 arm at rigid arm
 Base de fixation pour 1 bras au bras rigide
 Fijador para 1 brazo al brazo rígido
 Fissatore per 1 braccio al braccio rigido

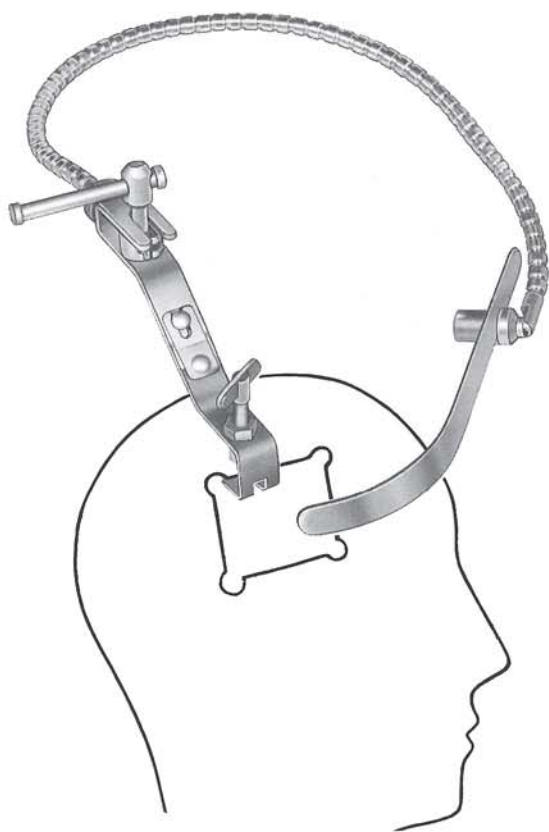

40.221.00

Hirnspatelhalter, selbsthaltend, flexibel,
für flache Spatel,
mit 1 Spannarm, komplett, bestehend aus:
40.220.05, 40.220.08, 40.220.09

Brain retractor, self retaining, flexible,
for flat spatula,
with 1 flexible arm, complete, consisting of:
40.220.05, 40.220.08, 40.220.09

Ecarteur autostatique, flexible,
pour des spatules plates,
avec un bras flexible, complet, composé de:
40.220.05, 40.220.08, 40.220.09

Separador autorretentivo, flexible,
para espátulas llanas,
con 1 brazo flexible, completo, compuesto de:
40.220.05, 40.220.08, 40.220.09

Divaricatore autostatico, flessibile,
per spatole piatte,
con 1 braccio flessibile, completo, composto da:
40.220.05, 40.220.08, 40.220.09

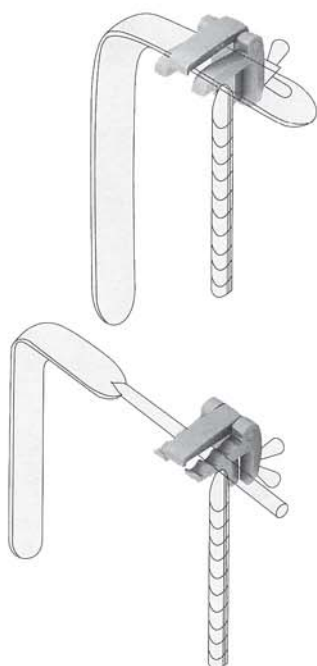

40.220.09 Halter für flache Hirnspatel
Holder for flat brain spatula
Support pour des spatules plates
Soporte para espátulas llanas
Sostegno per spatole piatte

40.220.10 Halter für Hirnspatel mit rundem Schaft
Holder for brain spatula with round stem
Support pour des spatules a tige ronde
Soporte para espátulas con vástago redondo
Sostegno per spatole con asta rotonda

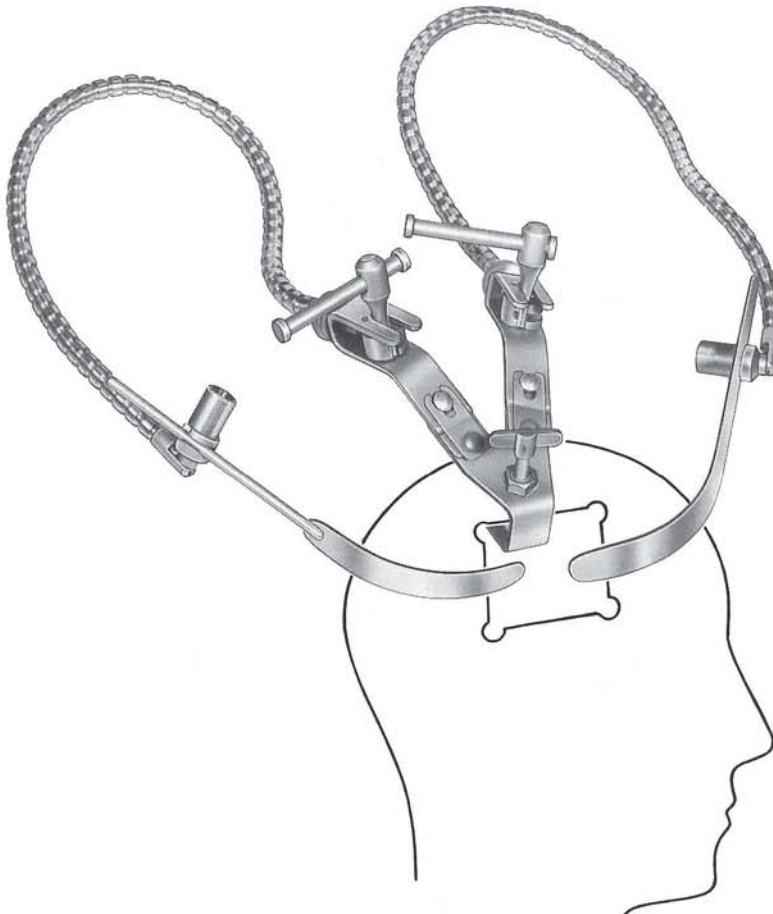

40.222.00

Hirnspatelhalter, selbsthaltend, flexibel,
für flache Spatel,
mit 2 Spannarmen, komplett, bestehend aus:
2 x 40.220.08, 40.220.06, 2 x 40.220.09

Brain retractor, self retaining, flexible,
for flat spatula,
with 2 flexible arms, complete, consisting of:
2 x 40.220.08, 40.220.06, 2 x 40.220.09

Ecarteur autostatique, flexible,
pour des spatules plates,
avec 2 bras flexibles, complet, composé de:
2 x 40.220.08, 40.220.06, 2 x 40.220.09

Separador autorretentivo, flexible,
para espátulas llanas,
con 2 brazos flexibles, completo, compuesto de:
2 x 40.220.08, 40.220.06, 2 x 40.220.09

Divaricatore autostatico, flessibile,
per spatole piatte,
con 2 bracci flessibili, completo, composto da:
2 x 40.220.08, 40.220.06, 2 x 40.220.09

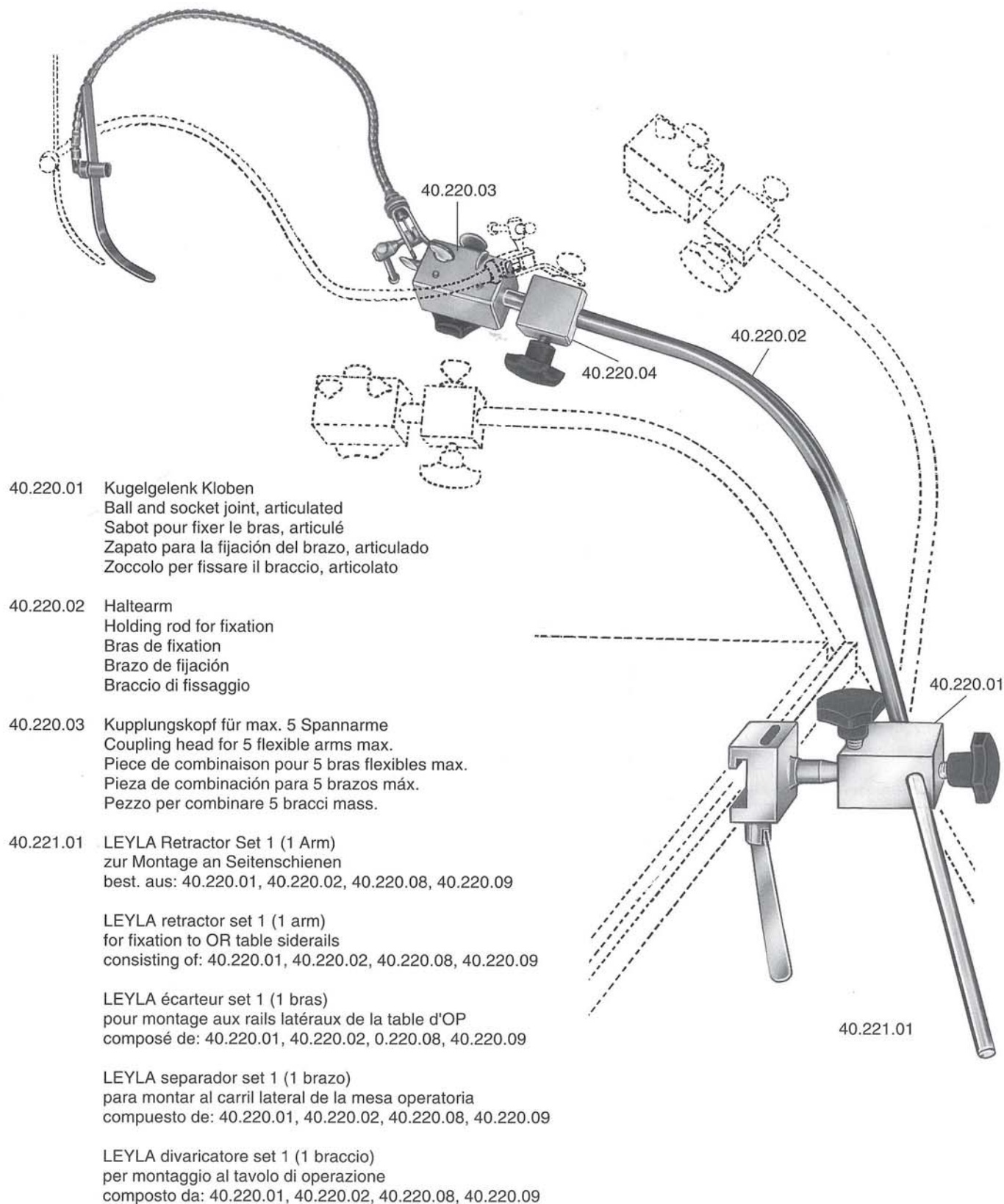

- 40.220.01 Kugelgelenk Kloben
 Ball and socket joint, articulated
 Sabot pour fixer le bras, articulé
 Zapato para la fijación del brazo, articulado
 Zoccolo per fissare il braccio, articolato
- 40.220.02 Haltearm
 Holding rod for fixation
 Bras de fixation
 Brazo de fijación
 Braccio di fissaggio
- 40.220.03 Kupplungskopf für max. 5 Spannarme
 Coupling head for 5 flexible arms max.
 Pièce de combinaison pour 5 bras flexibles max.
 Pieza de combinación para 5 brazos máx.
 Pezzo per combinare 5 bracci mass.
- 40.220.04 Kupplungskopf drehbar
 Coupling head rotatable
 Pièce de combinaison rotative
 Pieza de combinación giratoria
 Pezzo per combinare girevole
- 40.222.02 LEYLA Retractor Set 2 (2 Arme) zur Montage an Seitenschienen
 best. aus: 40.220.01, 40.220.02, 40.220.03, 40.220.04
 2 x 40.220.07, 2 x 40.220.08, 2 x 40.220.09

LEYLA retractor set 2 (2 arms) for fixation to OR table siderails
 consisting of: 40.220.01, 40.220.02, 40.220.03, 40.220.04
 2 x 40.220.07, 2 x 40.220.08, 2 x 40.220.09

LEYLA écarteur set 2 (2 bras) pour montage aux rails latéraux
 de la table d'OP
 composé de: 40.220.01, 40.220.02, 40.220.03, 40.220.04
 2 x 40.220.07, 2 x 40.220.08, 2 x 40.220.09

LEYLA separador set 2 (2 brazos) para montar al carril lateral de la
 mesa operatoria
 compuesto de: 40.220.01, 40.220.02, 40.220.03, 40.220.04
 2 x 40.220.07, 2 x 40.220.08, 2 x 40.220.09

LEYLA divaricatore set 2 (2 bracci) per montaggio
 al tavolo di operazione
 composto da: 40.220.01, 40.220.02, 40.220.03, 40.220.04,
 2 x 40.220.07, 2 x 40.220.08, 2 x 40.220.09

